

**CONECTORES CIRCULARES**  
**CIRCULAR CONNECTORS**  
**CONNECTEURS CYLINDRIQUES**





La política de la empresa, es fabricar conectores industriales de alta calidad y fiabilidad, para cumplir las exigentes necesidades de un mercado internacional; apoyándonos en nuestro experimentado equipo de I+D.

With a philosophy dedicated to customer satisfaction, our industrial connectors are manufactured to the highest standards of quality and reliability. Thanks to an experienced R+D department, we are able to meet the exacting requirements of world wide markets.

Notre usine a comme principe fondamental la fabrication de connecteurs industriels fiables et de grande qualité, afin de remplir toutes les conditions d'un marché international des plus exigeants, en s'appuyant sur l'expérience de notre équipe du bureau de recherche et développement.



# CARACTERÍSTICAS TÉCNICAS    TECHNICAL DATA    CARACTERISTIQUES TECHNIQUES

## CARACTERÍSTICAS MECÁNICAS    MECHANICAL DATA    CARACTÉRISTIQUES MÉCANIQUES

Cuerpo Shell Corps	Aleación de aluminio Aluminium Alloy Alliage d'aluminium
Protección Plating Protection	Niquelado químico / Anticorrosión, conductor o no conductor / Negro Electroless nickel / Anti-corrosion, conductive or non conductive / Black Nickel chimique / Anticorrosion, conducteur et non conducteur / Noire
Aislante Insulator Isolant	Termoduro / Neopreno / Termoplástico / PPS Thermoset / Neoprene / Thermoplastic / PPS Thermodur / Néoprène / Thermoplastique / PPS
Contacto Contacts Contacts	Aleación de cobre + Oro sobre níquel Copper alloy + Gold on nickel Alliage Cuivreux + Or (Au) sur sous couche nickel.
Estanqueidad Water proof Étanchéité	IP67 según norma IEC 529 / EN60529:1991 (de fábrica y conectado) IP67 conforming to IEC 529 / EN60529:1991 (from factory and mated) IP67 norme IEC 529 / EN 60529:1991 (de l'usine et accouplé)

## CARACTERÍSTICAS ELÉCTRICAS    ELECTRIC DATA    CARACTÉRISTIQUES ÉLECTRIQUES

CONTACTO    CONTACT    CONTACT	SOLDAR - SOLDER - A SOUDER				ENGASTAR - CRIMP - A SERTIR			
Símbolo - Symbol - Symbole	•	○	◐	⊕	•	○	◐	⊕
Ø Contacto macho (mm) Ø Male Contact (mm) Ø Contact mâle (mm)	1	1.5	3	5	1	1.5	3	5.75
Intensidad nominal (A) Working current (A) Intensité nominale (A)	7.5	10	25	50	7.5	10	25	80
Máx. sección de hilo (mm <sup>2</sup> ) Max. wire section (mm <sup>2</sup> ) Section de fil Max. (mm <sup>2</sup> )	0.75	1.75	5.1	13	0.75	2.5	4	16
Resistencia de contacto (mΩ) Contact resistance (mΩ) Résistance de contact (mΩ)	≤ 5				≤ 5			

## CARACTERÍSTICAS CLIMÁTICAS    ENVIRONMENTAL DATA    CARACTÉRISTIQUES CLIMATIQUES

	MATERIAL AISLANTE		INSULATOR MATERIAL		MATERIAU DE L'ISOLANT		PPS	
	MIN.	MAX.	MIN.	MAX.	MIN.	MAX.	MIN.	MAX.
Temperatura de servicio Operating temperature Température de service	-40°C	+85°C	-25°C	+90°C	-55°C	+125°C	-53°C	+220°C
Presna estopas estándar Standard cableclamp Presse-étoupes	Temperatura máxima Max. temperature Température maximale				85°C* 85°C* 85°C*			

\*Para temperaturas más altas: consultar fábrica

\*For higher temperatures: Contact Factory

\*Pour températures supérieures: consulter l'usine

### PROTECCIÓN CUERPO (Según norma ASTMB 117-73)

### SHELL PROTECTION (Confirming to ASTMB 117-73)

### TRAITEMENT (Norme ASTMB 117-73)

Resistencia a niebla salina Resistance to saline atmosphere Résistant à l'atmosphère saline	600 hours 600 heures	Solo acabado 2 (no conductor) y 6 (conductor) Only with plating 2 (non conductive) and 6 (conductive) Seulement en finition 2 (non conducteur) et 6 (conducteur)
---	-------------------------	--



9 ■ ■ 2 ■ ■ ■ ■ ■ ■ ■ ■ S ■ ■ ■ ■ ■

**Base Hembra**  
**Female Receptacle**  
**Embase Femelle**

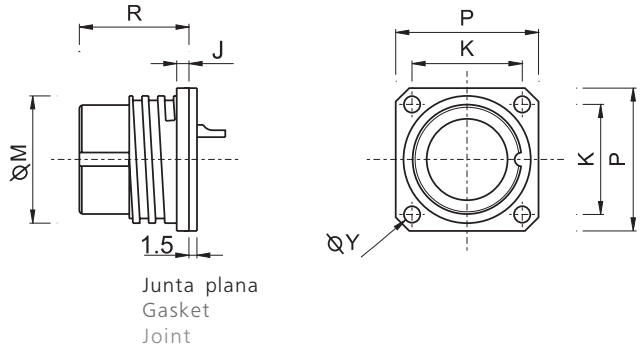

	K	ØM	P	R	ØY	J
T-10	19	21	25	24	3,2	2,5
T-20	24	28	31	25,3	3,2	2,8
T-30	34	42	46	25,3	3,2	2,8
T-40	41	52	56	25,3	3,2	2,8

9 ■ ■ 2 ■ ■ ■ ■ ■ ■ ■ ■ P ■ ■ ■ ■ ■

**Base Macho**  
**Male Receptacle**  
**Embase Mâle**

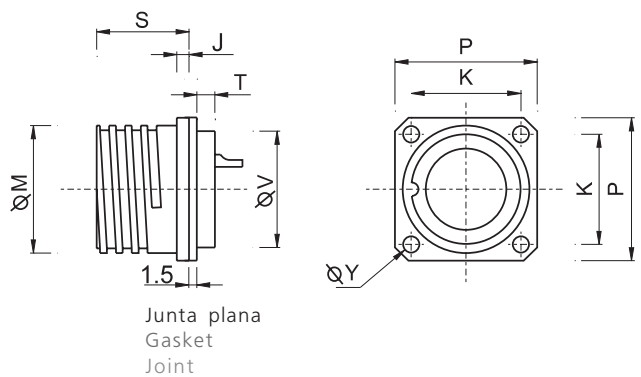

	K	ØM	P	S	ØV	ØY	J	T
T-10	19	21	25	17,5	16	3,2	2,5	5
T-20	24	28	31	20,5	25	3,5	2,5	4
T-30	34	42	46	20,5	35	3,5	2,8	4
T-40	41	52	56	20,5	45	3,5	2,8	4

Todas las cotas en mm

All dimensions in mm

Toutes les dimensions sont en mm



9 ■ ■ 1 ■ ■ ■ ■ ■ ■ ■ ■ S ■ ■ ■ ■

**Prolongador Hembra**  
**Female Extender**  
**Prolongateur Femelle**

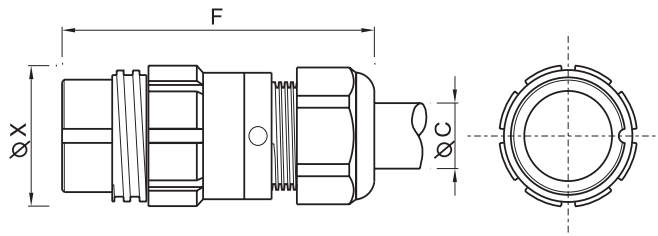

	PG	ØX	F
T-10	11	23,5	63,5
T-20	16	29,8	70,5
T-30	16	44,5	83
	29	44,5	93
T-40	29	57	91,5
	36	57	98

Para "ØC" ver pag. 13  
 For "ØC" see page 13  
 Pour "ØC" voir page 13

9 ■ ■ 3 ■ ■ ■ ■ ■ ■ ■ ■ S ■ ■ ■ ■

**Prolongador Hembra con Cuello Largo**  
**Female Extender with Long Backshell**  
**Prolongateur Femelle Corps Long**

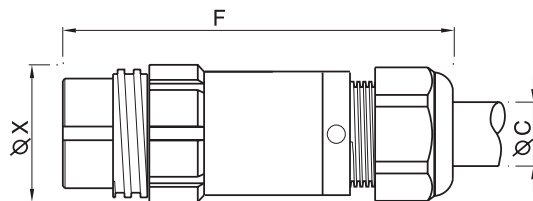

	PG	ØX	F
T-10	11	23,5	*
T-20	16	29,8	*
T-30	16	44,5	*
	29	44,5	115,50
T-40	29	57	135
	36	57	141,50

Para "ØC" ver pag. 13  
 For "ØC" see page 13  
 Pour "ØC" voir page 13

\* Consultar fábrica  
 \* Contact factory  
 \* Consulter l'usine

Todas las cotas en mm

All dimensions in mm

Toutes les dimensions sont en mm



9 ■ ■ 1 ■ ■ ■ ■ ■ ■ ■ ■ P ■ ■ ■ ■ ■

**Prolongador Macho**  
**Male Extender**  
**Prolongateur Mâle**

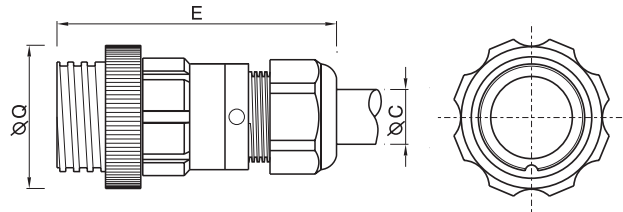

	PG	ØQ	E
T-10	11	24	60
T-20	16	32	72,5
T-30	16	46	93,5
	29	46	93,5
T-40	29	62	95
	36	62	98,5

Para "ØC" ver pag. 13  
 For "ØC" see page 13  
 Pour "ØC" voir page 13

9 ■ ■ 3 ■ ■ ■ ■ ■ ■ ■ ■ P ■ ■ ■ ■ ■

**Prolongador Macho con Cuello Largo**  
**Male Extender with Long Backshell**  
**Prolongateur Mâle Corps Long**

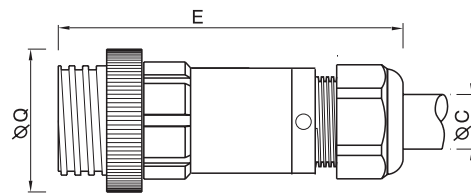

	PG	ØQ	E
T-10	11	24	*
T-20	16	32	*
T-30	16	46	*
	29	46	116
T-40	29	62	132
	36	62	142

Para "ØC" ver pag. 13  
 For "ØC" see page 13  
 Pour "ØC" voir page 13

\* Consultar fábrica  
 \* Contact factory  
 \* Consulter l'usine

Todas las cotas en mm

All dimensions in mm

Toutes les dimensions sont en mm



9 ■ ■ ■ 6 ■ ■ ■ ■ ■ ■ ■ ■ S ■ ■ ■ ■ ■

**Ficha Hembra**  
**Straight Female Plug**  
**Fiche Femelle**

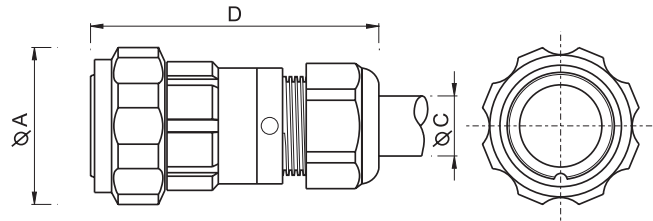

	PG	ØA	D
T-10	11	27,5	58
T-20	16	36,5	68
T-30	16	52	89,5
	29	52	79,5
T-40	29	64,5	90
	36	64,5	93,5

Para "ØC" ver pag. 13  
 For "ØC" see page 13  
 Pour "ØC" voir page 13

9 ■ ■ ■ 7 ■ ■ ■ ■ ■ ■ ■ ■ S ■ ■ ■ ■ ■

**Ficha Hembra con Cuello Largo**  
**Straight Female Plug with Long Backshell**  
**Fiche Femelle Corps Long**

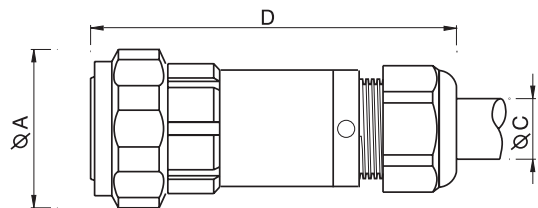

	PG	ØA	D
T-10	11	27,5	*
T-20	16	36,5	*
T-30	16	52	*
	29	52	111
T-40	29	64,5	127
	36	64,5	137

Para "ØC" ver pag. 13  
 For "ØC" see page 13  
 Pour "ØC" voir page 13

\* Consultar fábrica  
 \* Contact factory  
 \* Consulter l'usine

Todas las cotas en mm

All dimensions in mm

Toutes les dimensions sont en mm



9 ■ ■ 6 ■ ■ ■ ■ ■ ■ ■ ■ P ■ ■ ■ ■ ■

**Ficha Macho**  
**Straight Male Plug**  
**Fiche Mâle**

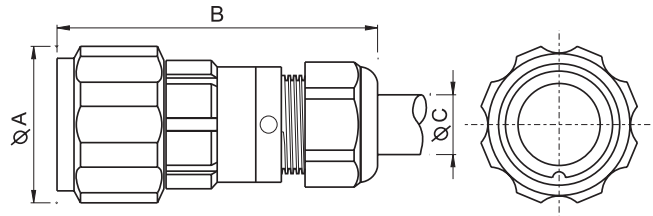

	PG	ØA	B
T-10	11	27,5	66,5
T-20	16	36,5	75,5
T-30	16	52	97,5
	29	52	86,5
T-40	29	64,5	96,5
	36	64,5	100

Para "ØC" ver pag. 13  
 For "ØC" see page 13  
 Pour "ØC" voir page 13

9 ■ ■ 7 ■ ■ ■ ■ ■ ■ ■ ■ P ■ ■ ■ ■ ■

**Ficha Macho con Cuello Largo**  
**Straight Male Plug with Long Backshell**  
**Fiche Mâle Corps Long**

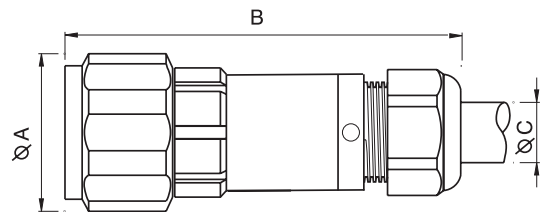

	PG	ØA	B
T-10	11	27,5	*
T-20	16	36,5	*
T-30	16	52	*
	29	52	119
T-40	29	64,5	133,5
	36	64,5	143,5

Para "ØC" ver pag. 13  
 For "ØC" see page 13  
 Pour "ØC" voir page 13

\* Consultar fábrica  
 \* Contact factory  
 \* Consulter l'usine

Todas las cotas en mm

All dimensions in mm

Toutes les dimensions sont en mm





9 8 S

**Ficha Codo Hembra**  
**Female Angled Plug**  
**Fiche Femelle Coudée**

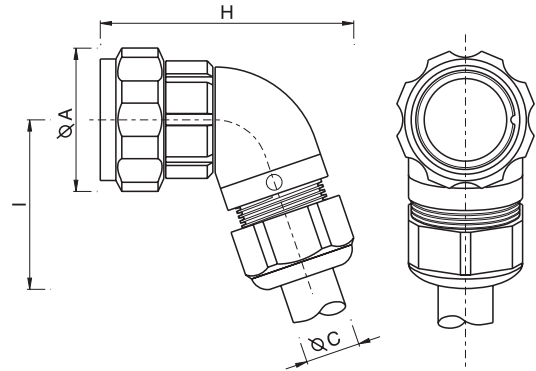

	PG	ØA	H	I
T-10	11	27,5	55	40
T-20	16	36,5	68,5	48
T-30	16	52	*	*
	29	52	84	61
T-40	29	64,5	90	71
	36	64,5	97	82

Para "ØC" ver pag. 13  
 For "ØC" see page 13  
 Pour "ØC" voir page 13

\* Consultar fábrica  
 \* Contact factory  
 \* Consulter l'usine

9 8 P

**Ficha Codo Macho**  
**Male Angled Plug**  
**Fiche Mâle Coudée**

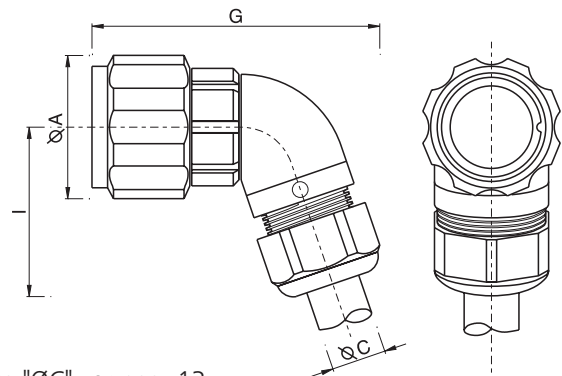

	PG	ØA	I	G
T-10	11	27,5	40	63,5
T-20	16	36,5	48	76
T-30	16	52	*	*
	29	52	61	91
T-40	29	64,5	71	96,5
	36	64,5	82	103,5

Para "ØC" ver pag. 13  
 For "ØC" see page 13  
 Pour "ØC" voir page 13

\* Consultar fábrica  
 \* Contact factory  
 \* Consulter l'usine

Todas las cotas en mm

All dimensions in mm

Toutes les dimensions sont en mm



9 ■ ■ 9 ■ ■ ■ ■ ■ ■ ■ ■ P ■ ■ ■ ■

**Base Racord Macho**  
**Male Receptacle with Coupling Nut**  
**Embase Mâle à Ecrou**

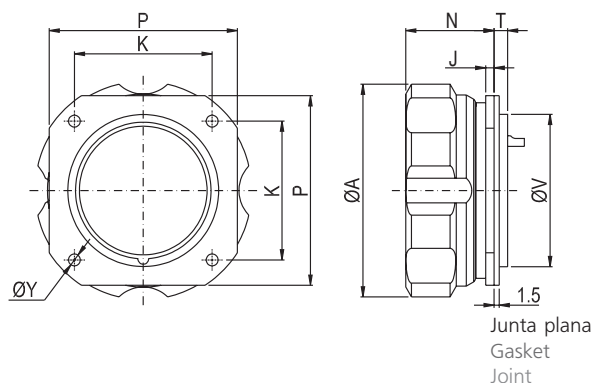

	ØA	K	P	T	ØV	ØY	J	N
T-10	27,5	19	25	5	16	3,2	2,5	25,5
T-20	36,5	24	31	4	25	3,5	2,8	26,5
T-30	52	34	46	4	35	3,5	2,8	26,5
T-40	64,5	41	56	4	45	3,5	2,8	26,5

9 ■ ■ 9 ■ ■ ■ ■ ■ ■ ■ ■ S ■ ■ ■ ■

**Base Racord Hembra**  
**Female Receptacle with Coupling Nut**  
**Embase Femelle à Ecrou**

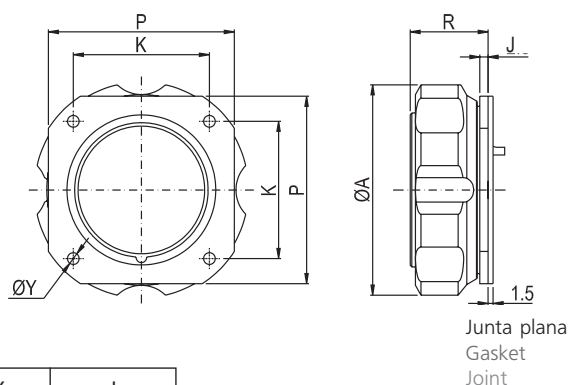

	ØA	K	P	R	ØY	J
T-10	27,5	19	25	24	3,2	2,5
T-20	36,5	24	31	25,3	3,2	2,8
T-30	52	34	46	25,3	3,2	2,8
T-40	64,5	41	56	25,3	3,2	2,8

TORNILLO M3 DIN85  
 SCREW M3 DIN85  
 VIS M3 DIN85

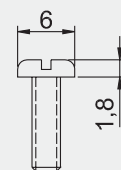

Consultar fábrica para versiones bayoneta, antivibratorio y manfíbio.  
 Contact factory for bayonet, antivibration and manfíbio series.  
 Consulter l'usine pour la série à baïonnette, antivibratoire et manfíbio.

Para fijación a panel recomendamos utilizar tornillos con las dimensiones máximas de la figura.  
 We recommend the use of screws with the maximum dimensions as shown on the drawing.  
 Pour la fixation sur panneau veuillez utiliser les vis M3 de dimensions maximales indiquées ci-dessus.

Todas las cotas en mm

All dimensions in mm

Toutes les dimensions sont en mm



**DIMENSIONES DE LOS  
CONECTORES ENSAMBLADOS**

**DIMENSIONS OF  
MATED CONNECTORS**

**ENCOMBREMENT DES  
CONNECTEURS ACCOUPLES**

9 2 P + 9 6 S

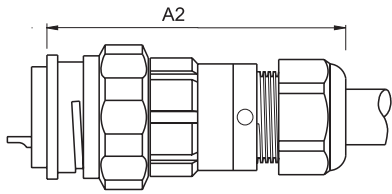

9 2 S + 9 6 P

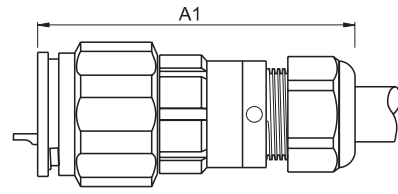

9 2 P + 9 8 S

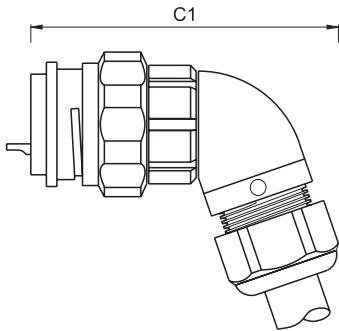

9 2 S + 9 8 P

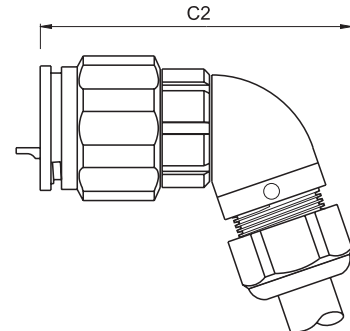

9 9 P + 9 1 S

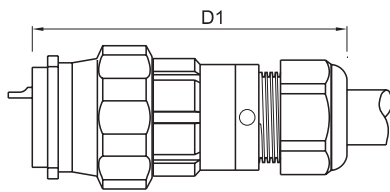

9 9 S + 9 1 P

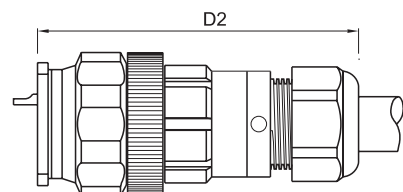

9 1 P + 9 6 S

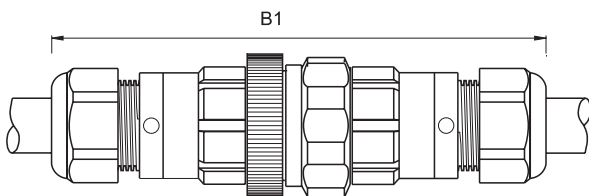

9 1 S + 9 6 P

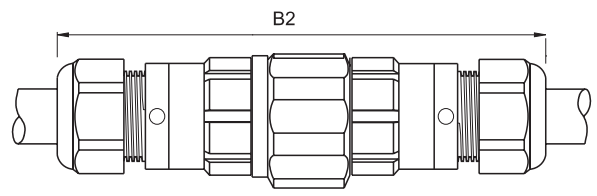

	PG	A1	A2	B1	B2	C1	C2	D1	D2
T-10	11	73	66.5	108.5	111.5	62.5	68.5	70.5	74
T-20	16	84	78	129	129	78	84.5	80	87
T-30	16	106	101	175	173.5			103	109
	29	95	90	153	151.5	91	96.5	92	98
T-40	29	104	98.5	172.5	174.5	97.5	103.5	103.5	107
	36	107.5	102	179.5	181.5	104.5	111	107	110.5

Todas las cotas en mm

All dimensions in mm

Toutes les dimensions sont en mm



Tamaño del Conector Connector Size Taille du Connecteur	Ø del cable Cable Ø Ø du câble		PG	Referencia Reference Référence
	Min.	Max		
10	4	10	11	D
20	6	12	16	A
	9	14		B
30	6	12	16	A*
	9	14		B*
	11	20	29	C
	14	25		D
40	11	20	29	A
	14	25		B
	22	32	36	D

\* Solo para: Prolongador y ficha recta \* Only for: Extender and straight plug \* Seulement pour: Prolongateur et fiche droite



Además de nuestros prensaestopas estandar de plástico podemos suministrar alternativas para cubrir cualquier necesidad como: Prensa estopas metálico, protección EMI, continuidad de masa, espiral flexible, cable rígido..., consultar a fábrica para más información.

We can also supply alternatives to our standard range of cable clamps in plastic: metal glands, EMI/RFI shielding glands, glands for earth continuity with earthed shells and for rigid conduits as well as spiral glands for flexible cable. Contact factory for more information.

Nous pouvons vous proposer tous les types de presse-étoupes pour vos besoins; presse-étoupe métalliques, protection EMI, continuité de masse, conduits souples, câble rigide, sortie de câbles multiples. Consulter l'usine pour plus d'information.







9 ■ ■ 1 ■ ■ ■ ■ ■ ■ ■ ■ P ■ ■ ■

<b>Prolongador</b>	ver pag. 7
<b>Extender</b>	see page 7
<b>Prolongateur</b>	voir page 7



9 ■ ■ 2 ■ ■ ■ ■ ■ ■ ■ ■ P ■ ■ ■

<b>Base</b>	ver pag. 5
<b>Receptacle</b>	see page 5
<b>Embase</b>	voir page 5



9 ■ ■ 3 ■ ■ ■ ■ ■ ■ ■ ■ P ■ ■ ■

<b>Prolongador con cuello largo</b>	ver pag. 7
<b>Extender with longer backshell</b>	see page 7
<b>Prolongateur corps long</b>	voir page 7



9 ■ ■ 6 ■ ■ ■ ■ ■ ■ ■ ■ P ■ ■ ■

<b>Ficha</b>	ver pag. 9
<b>Straight plug</b>	see page 9
<b>Fiche</b>	voir page 9



9 ■ ■ 7 ■ ■ ■ ■ ■ ■ ■ ■ P ■ ■ ■

<b>Ficha con cuello largo</b>	ver pag 9
<b>Straight plug with longer backshell</b>	see page 9
<b>Fiche corps long</b>	voir page 9



9 ■ ■ 8 ■ ■ ■ ■ ■ ■ ■ ■ P ■ ■ ■

<b>Ficha codo</b>	ver pag. 10
<b>Angled Plug</b>	see page 10
<b>Fiche coudée</b>	voir page 10



9 ■ ■ 9 ■ ■ ■ ■ ■ ■ ■ ■ P ■ ■ ■

<b>Base racord</b>	ver pag. 11
<b>Receptacle with coupling ring</b>	see page 11
<b>Embase à écrou</b>	voir page 11



9 ■ ■ 1 ■ ■ ■ ■ ■ ■ ■ ■ S ■ ■ ■

<b>Prolongador</b>	ver pag. 6
--------------------	------------

<b>Extender</b>	see page 6
-----------------	------------

<b>Prolongateur</b>	voir page 6
---------------------	-------------



9 ■ ■ 2 ■ ■ ■ ■ ■ ■ ■ ■ S ■ ■ ■

<b>Base</b>	ver pag. 5
-------------	------------

<b>Receptacle</b>	see page 5
-------------------	------------

<b>Embase</b>	voir page 5
---------------	-------------



9 ■ ■ 3 ■ ■ ■ ■ ■ ■ ■ ■ S ■ ■ ■

<b>Prolongador con cuello largo</b>	ver pag. 6
-------------------------------------	------------

<b>Extender with longer backshell</b>	see page 6
---------------------------------------	------------

<b>Prolongateur corps long</b>	voir page 6
--------------------------------	-------------



9 ■ ■ 6 ■ ■ ■ ■ ■ ■ ■ ■ S ■ ■ ■

<b>Ficha</b>	ver pag. 8
--------------	------------

<b>Straight plug</b>	see page 8
----------------------	------------

<b>Fiche</b>	voir page 8
--------------	-------------



9 ■ ■ 7 ■ ■ ■ ■ ■ ■ ■ ■ S ■ ■ ■

<b>Ficha con cuello largo</b>	ver pag. 8
-------------------------------	------------

<b>Straight plug with longer backshell</b>	see page 8
--	------------

<b>Fiche corps long</b>	voir page 8
-------------------------	-------------



9 ■ ■ 8 ■ ■ ■ ■ ■ ■ ■ ■ S ■ ■ ■

<b>Ficha codo</b>	ver pag. 10
-------------------	-------------

<b>Angled Plug</b>	see page 10
--------------------	-------------

<b>Fiche coudée</b>	voir page 10
---------------------	--------------



9 ■ ■ 9 ■ ■ ■ ■ ■ ■ ■ ■ S ■ ■ ■

<b>Base racord</b>	ver pag. 11
--------------------	-------------



























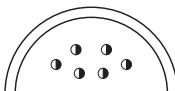

<b>Receptacle with coupling ring</b>	see page 11
--------------------------------------	-------------

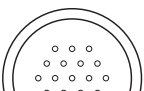
<b>Embase à écrou</b>	voir page 11
-----------------------	--------------

CONTACTOS A SOLDAR

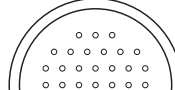
SOLDER CONTACTS

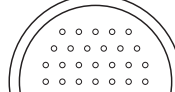
CONTACTS À SOUDER

T-10	T-20	T-30	T-40
 <b>13U</b> 270 1.400 T	 <b>22B</b> 490 2.100 T	 <b>32F</b> 525 1.750 T	 <b>47M</b> 420 2.500 T
 <b>14V</b> 225 1.400 T	 <b>23C</b> 440 1.400 T	 <b>34H</b> 490 1.750 T	 <b>48M</b> 420 2.500 T
 <b>17P</b> 150 1.050 T	 <b>23AL</b> 540 1.750 T	 <b>37Y</b> 470 1.750 T	 <b>413AB</b> 420 1.750 T
 <b>25D</b> 370 1.400 T	 <b>25S</b> 370 1.400 T	 <b>39J</b> 450 1.750 T	 <b>419AR</b> 400 1.750 T
 <b>26R</b> 300 1.400 T	 <b>27E</b> 370 1.400 T	 <b>315K</b> 355 1.750 T	 <b>422AC</b> 355 1.750 T
 <b>27X</b> 300 1.400 T	 <b>28T</b> 270 1.400 T	 <b>319L</b> 390 1.750 T	 <b>424AA</b> 355 1.750 T
 <b>29AE</b> 280 1.400 T	 <b>210AO</b> 280 1.050 T	 <b>337P</b> 175 2.100 N	 <b>439R</b> 270 1.750 T
 <b>212AF</b> 270 1.050 T	 <b>213AN</b> 270 1.050 T	 <b>443AP</b> 300 1.750 T	
 <b>222P</b> 150 1.050 N			

Todos los conectores a soldar excepto los aislantes 222P y 337P están reconocidos UL 

All solder connectors except the insulators 222P and 337P are recognised UL 

Tous les connecteurs à souder sauf les isolants 222P et 337P sont reconnus UL 





# CONTACTOS A ENGASTAR

# CRIMP CONTACTS

# CONTACTS À SERTIR

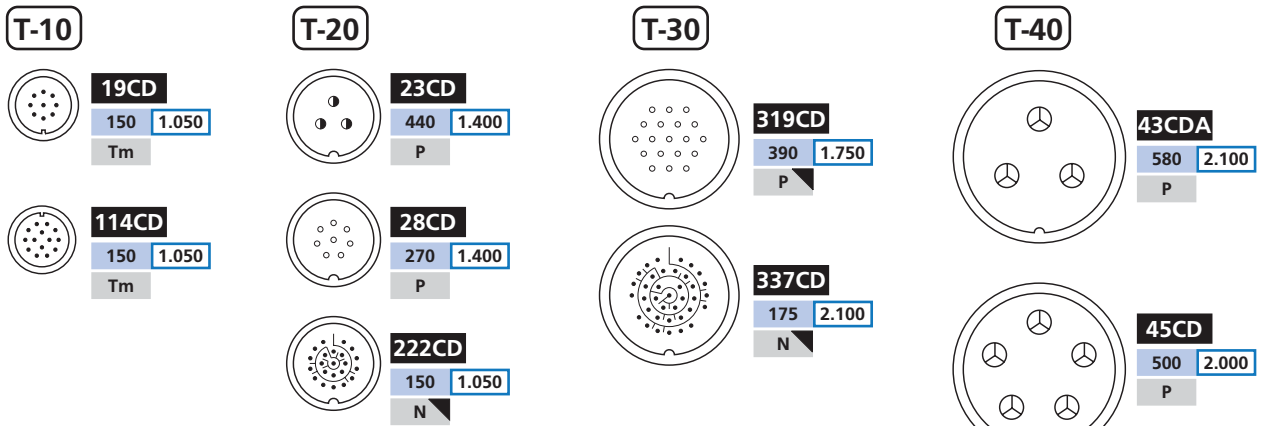

### Características Eléctricas Electrical Data Caractéristiques Électriques

	Contactos a Soldar Solder Contacts Contacts à Souder				Contactos a Engastar Crimp Contacts Contacts à Sertir			
	●	○	◐	⊕	●	○	◐	⊕
Ø Contacto Macho (mm) Ø Male Contact (mm) Ø Contact Mâle (mm)	1	1,5	3	5	1	1,5	3	5,75
Intensidad Nominal (A) Working Current (A) Intensité Nominale (A)	7,5	10	25	50	7,5	10	25	80
Sección Max. Cable (mm <sup>2</sup> ) Max Wire Section (mm <sup>2</sup> ) Section Câble Max (mm <sup>2</sup> )	0,75	1,75	5,1	13	0,25-0,75	0,75 1,5 2,5	1 2,5 4	16
Resistencia de contacto (mΩ) Contact Resistance (mΩ) Résistance de Contact (mΩ)	≤ 5				≤ 5			

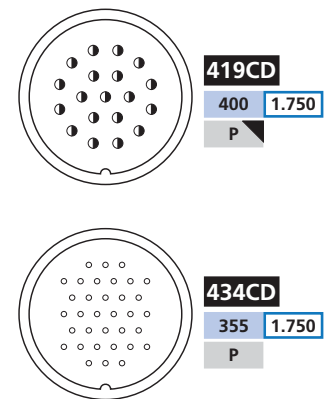

### CONTACTOS Y ÚTILES DE ENGASTADO CRIMP CONTACTS AND TOOLS CONTACTS ET OUTILS A SERTIR

Aislante Insulator Isolant	Sección del cable Wire section Section du câble		Referencia de contacto Contact part number Référence du contact		Útiles de engastado Crimp tools Outils à sertir				
	mm <sup>2</sup>	AWG	Macho Male Mâle	Hembra Female Femelle	Tenaza Fija Simple Tool Pince Simple	Tenaza Regulable Adjustable Tool Pince Réglable	Torreta Positionner Positionneur	Insertor Insertion Insertion	Extractor Extraction Extraction
19CD 114CD	0,25 - 0,75	20 - 24	PXC12	SXC10	HOHT - 1440	—	—	701	702-3
28CD 319CD 434CD	0,75 1,5 2,5	18 - 19 15 - 16 13 - 15	PXC115 PXC89 PXC91	SXC114 SXC88 SXC90	—	HOM309	HOSH480	—	92UE65
222CD 337CD	0,25 - 0,75 0,5 - 1	20 - 24 18 - 22	PXC615 PXC148	SXC614 SXC149	— —	HOAF8 HOAF8	HOTH633 HOTH633	701 701	702-3 702-3
23CD 419CD	1,5 2,5 4	16 12 10 - 12	PXC86 PXC82 PXC140	SXC85 SXC81 SXC139	—	HOM309	HOSH480	—	92UE125
43CDA 45CD	16	4	PXC693	SXC695	—	*	*	—	92UE715

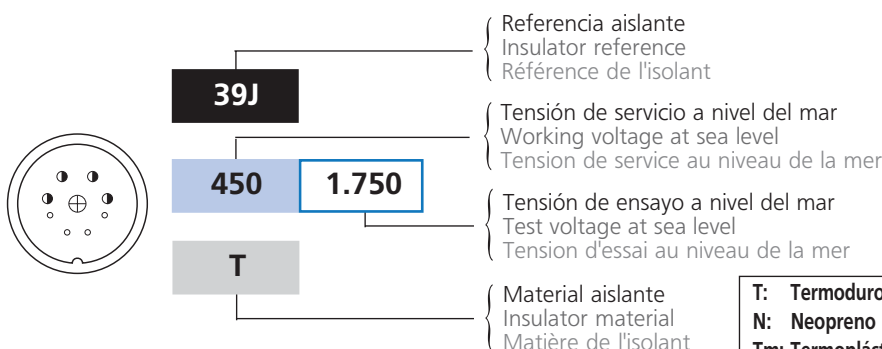

\* Consultar fábrica  
\* Contact factory  
\* Consulter l'usine

<b>T:</b> Termoduro	Thermo-hard	Thermodur
<b>N:</b> Neopreno	Neoprene	Néoprène
<b>Tm:</b> Termoplástico	Thermoplastic	Thermoplastique
<b>P:</b> PPS	PPS	PPS



# TAPONES METÁLICOS

# METAL CAPS

# BOUCHONS METALLIQUES

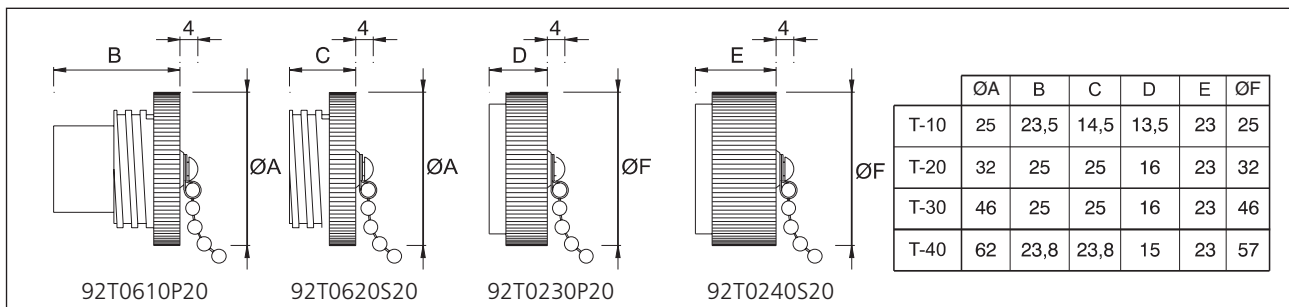

## 9 T 2

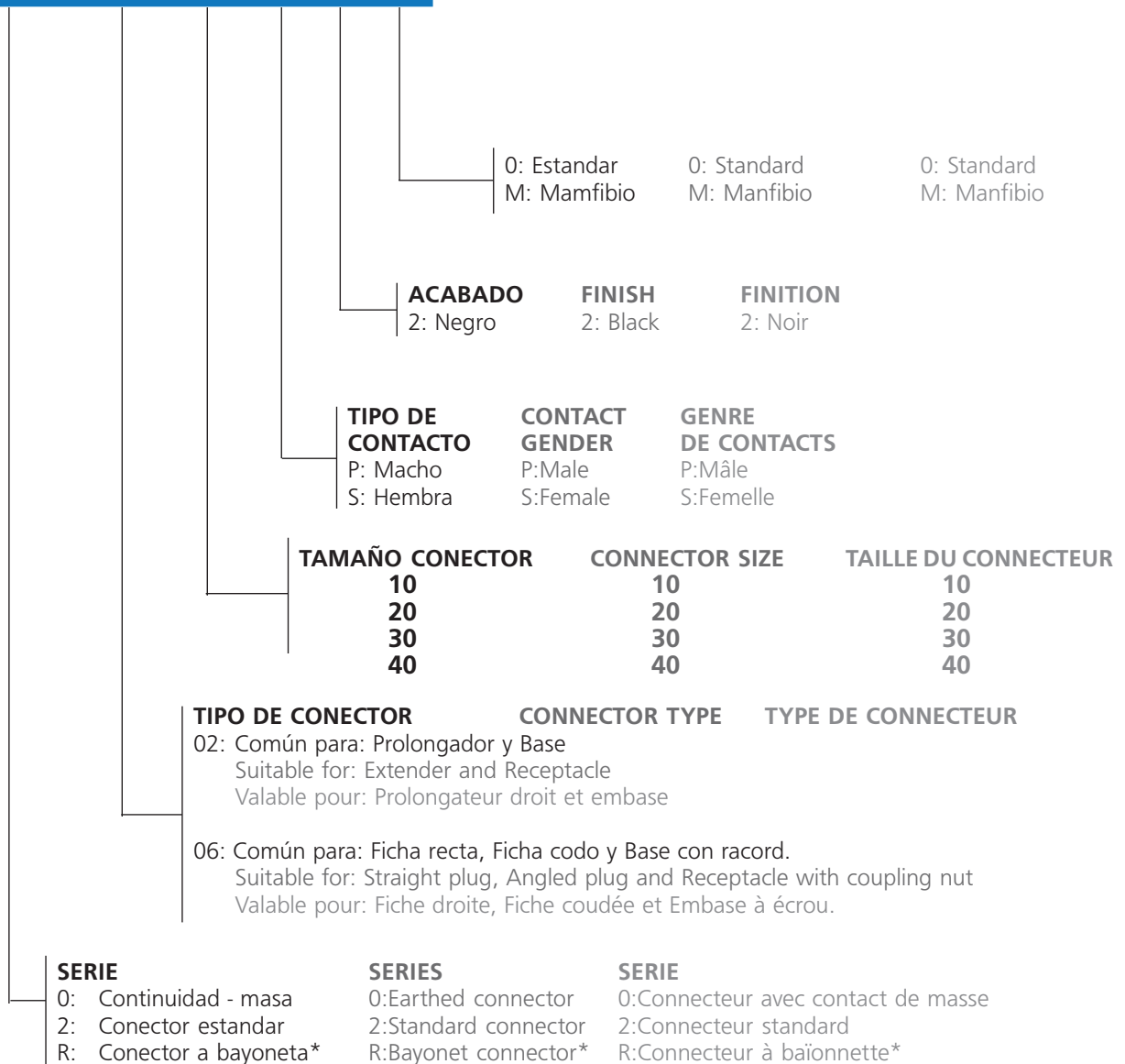

\* Consultar fábrica para versiones bayoneta, antivibratorio y manfibio.

\* Contact factory for bayonet, antivibration and manfibio series.

\* Consulter l'usine pour la série à baïonnette, antivibratoire et manfibio.

# ACCESORIOS

# ACCESSORIES

# ACCESSOIRES

CAPERUZA DE ESTANQUEIDAD  
PARA BASES (GOMA)

WATER PROOF BOOT  
FOR RECEPTACLES (RUBBER)

MANCHON D'ÉTANCHÉITÉ  
D'EMBASE (CAOUTCHOUC)

ÚTIL DE MONTAR  
CUERPOS

ASSEMBLY  
TOOLS

OUTILS DE  
BLOCCAGE

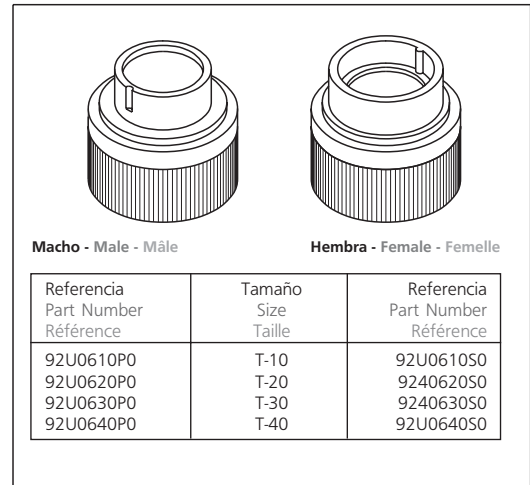
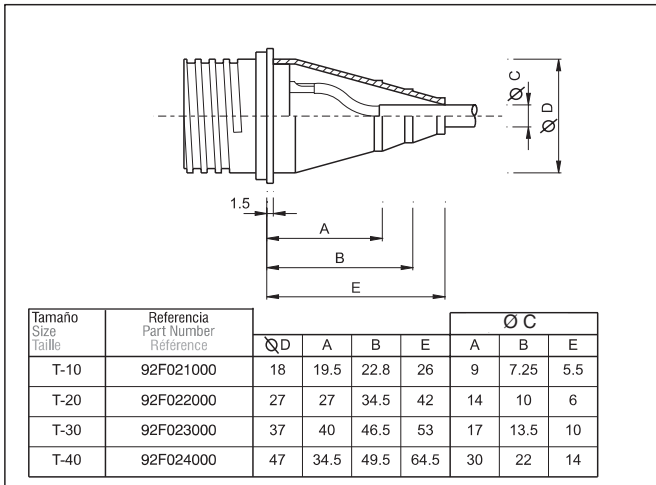

## TAPÓN GOMA

## RUBBER CAP

## BOUCHON EN CAOUTCHOUC

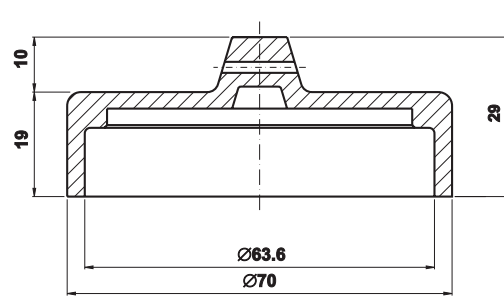
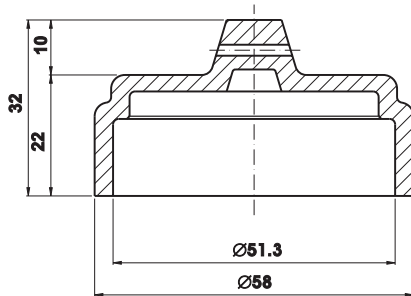

92TG040V	Referencia Part Number Référence	92TGR40V																																										
Común a las versiones	Suitable for	Valable pour																																										
<table border="1"> <tr><td>9</td><td>1</td><td>P</td></tr> <tr><td>9</td><td>1</td><td>S</td></tr> <tr><td>9</td><td>2</td><td>P</td></tr> <tr><td>9</td><td>2</td><td>S</td></tr> <tr><td>9</td><td>3</td><td>P</td></tr> <tr><td>9</td><td>3</td><td>S</td></tr> </table>	9	1	P	9	1	S	9	2	P	9	2	S	9	3	P	9	3	S	<p>Tamaño T-40 Size T-40 Taille T-40</p>	<table border="1"> <tr><td>9</td><td>6</td><td>P</td></tr> <tr><td>9</td><td>6</td><td>S</td></tr> <tr><td>9</td><td>7</td><td>P</td></tr> <tr><td>9</td><td>7</td><td>S</td></tr> <tr><td>9</td><td>8</td><td>P</td></tr> <tr><td>9</td><td>8</td><td>S</td></tr> <tr><td>9</td><td>9</td><td>P</td></tr> <tr><td>9</td><td>9</td><td>S</td></tr> </table>	9	6	P	9	6	S	9	7	P	9	7	S	9	8	P	9	8	S	9	9	P	9	9	S
9	1	P																																										
9	1	S																																										
9	2	P																																										
9	2	S																																										
9	3	P																																										
9	3	S																																										
9	6	P																																										
9	6	S																																										
9	7	P																																										
9	7	S																																										
9	8	P																																										
9	8	S																																										
9	9	P																																										
9	9	S																																										
<table border="1"> <tr><td>9</td><td>6</td><td>P</td></tr> <tr><td>9</td><td>6</td><td>S</td></tr> <tr><td>9</td><td>7</td><td>P</td></tr> <tr><td>9</td><td>7</td><td>S</td></tr> <tr><td>9</td><td>8</td><td>P</td></tr> <tr><td>9</td><td>8</td><td>S</td></tr> <tr><td>9</td><td>9</td><td>P</td></tr> <tr><td>9</td><td>9</td><td>S</td></tr> </table>	9	6	P	9	6	S	9	7	P	9	7	S	9	8	P	9	8	S	9	9	P	9	9	S	<p>Tamaño T-30 Size T-30 Taille T-30</p>																			
9	6	P																																										
9	6	S																																										
9	7	P																																										
9	7	S																																										
9	8	P																																										
9	8	S																																										
9	9	P																																										
9	9	S																																										



Dos de los sectores industriales que demandan el uso de nuestros conectores circulares son; el de la iluminación y el de sonido. Estos exigen unas características específicas como:

- 1º Un contacto de masa más largo para; avanzar la conexión y retrasar la desconexión.
- 2º Un acabado en negro para evitar la reflexión de la luz y para aislar hasta una tensión de 1.000V.
- 3º Un prensaestopas específico para la salida de mangueras independientes conservando así su IP-67.
- 4º Un cuello más largo para facilitar su manejo, colocar etiquetas de líneas y atenuar la tensión en el cable.

The following features have been incorporated to conform to sound + light industry requirements.

- 1º Extended male and earthed female contacts for make first/break last connection.
- 2º Black finish to avoid light reflection, and non conductive up to 1.000V.
- 3º Individual strain relief on spiders for IP67 protection.
- 4º Long backshell for a better grip and plenty of space for labelling.

Le secteur de l'illumination requiert l'utilisation de connecteurs cylindriques avec des caractéristiques adaptées:

- 1º Un contact de masse plus long qui est le premier et dernier connecté deconnecté.
- 2º Une finition en noir pour éviter les éblouissements et une tension d'isolement de 1.000V.
- 3º Un presse-étoupe adapté pour la sortie de manchons indépendants pour maintenir l'étanchéité de IP-67.
- 4º Un corps plus long pour faciliter la manipulation du connecteur, coller des étiquettes et atténuer les efforts de traction sur le câble.





El conector de bayoneta tiene dos cualidades a destacar, la rapidez de conexión y desconexión, y el de ser antivibratorio cuando está conectado.

Una vez conectado tiene una estanqueidad IP65.

Sólo disponible con acabado anticorrosivo 2 (no conductor) y 6 (conductor).

The bayonet connector allows fast mating and un-mating together with superior resistance to vibrations, and environmental sealing to IP65. The connector parts snap into place with an audible click.

Only available with anticorrosion finish 2 (non conductive) and 6 (conductive).

Le connecteur à baïonnette possède deux qualités principales. La première est la rapidité de connexion et de déconnexion. La deuxième est que ce verrouillage rend ce connecteur antivibratoire. Les connecteurs assemblés ont une étanchéité IP65. Seulement disponible avec la finition 2 (no conducteur) et 6 (conducteur).

**MANFIBIO****MANFIBIO****MANFIBIO**

Los conectores circulares "manfibio" se caracterizan por tener una junta tórica extra, que protege la rosca del conector de agentes corrosivos cuando están ensamblados. Al mismo tiempo están protegidos con un baño anticorrosivo, pudiendo ser este mismo conductor o no conductor. Estos conectores son recomendables para ambientes agresivos.

The "manfibio" circular connectors incorporate extra sealing devices to seal the thread on the receptacle from external corrosive elements when mated. Metal parts of the connector are resistant to harsh environments, thanks to an anticorrosive plating, which can be either conductive or non conductive.

Les connecteurs "manfibio" sont équipés d'un joint torique qui protège le filetage du connecteur des agressions extérieures. Les connecteurs son traités avec un bain anticorrosion, qui peut être conducteur ou isolant. Ces connecteurs son préconisés dans des milieux hostiles et agressifs.



Los conectores "Serie 90" se caracterizan por tener un contacto más largo (normalmente el nº 1) que conectado a la carcasa, aseguran la continuidad de masa y favorecen una buena protección EMI. (No válido para el acabado 2).

The connectors from our "Series 90" combine an extended earth pin (usually pin nº 1) for make first/break last connection together with an earthed shell (Not available for connectors with finish 2).

Les connecteurs de la série 90 sont caractérisés par un contact plus long (normalement le nº 1) relié au corps. Ce contact permet la continuité de masse et assure une bonne protection EMI. (N'est pas valable en finition 2).

SERIE ALTA TENSIÓN (AT)

HIGH VOLTAGE SERIES (AT)

SERIE HAUTE TENSION (AT)

Los conectores circulares "Serie AT", monocontacto, del tamaño T-20 son los idóneos para situaciones donde se trabaja con tensiones de servicio de hasta 6 kV. Disponible solamente en ficha macho y base hembra.

The circular connectors "Series AT", unipolar, size T-20, are ideal for high voltage requirements, up to 6 kV. Only male plug and female receptacle available.

Les connecteurs cylindriques "serie AT" mono contact, taille T-20, sont préconisés pour des tensions de service de 6 kV. Seulement disponible avec la fiche mâle et l'embase femelle.

FICHA MACHO, AT-21

MALE STRAIGHT PLUG, AT-21

FICHE MÂLE, AT-21



920621AT00PDO

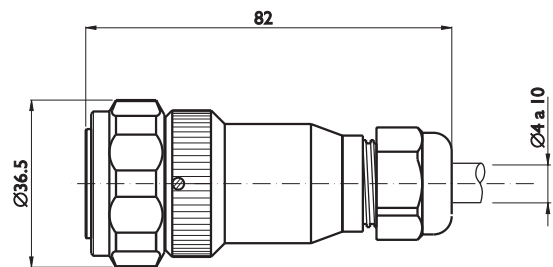

BASE HEMBRA, AT-21

FEMALE RECEPTACLE, AT-21

EMBASE FEMELLE, AT-21



920221AT00S00

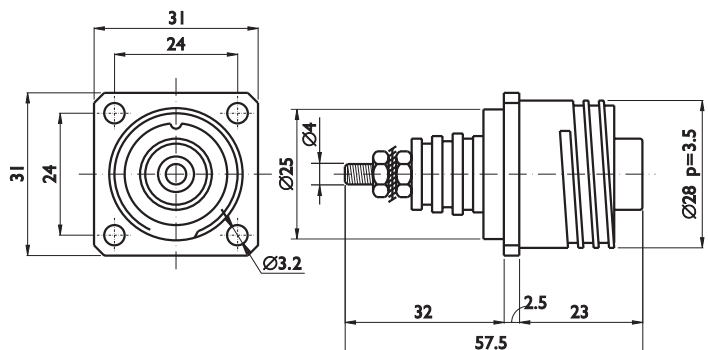

Todas las cotas en mm

All dimensions in mm

Toutes les dimensions sont en mm



La característica principal de estos conectores es su concepción en material Termoplástico Durethan BKV, con carga de fibra de vidrio.

Cumplen las especificaciones de la Comisión Electrotécnica Internacional (CEI) en la categoría 665. Su color es negro.

Son totalmente interconexionables con los conectores metálicos del tamaño 20 en su versión Ficha hembra Base macho, utilizando los mismos aislantes (pag. 17 y 18). Esta serie se compone de Fichas hembra rectas, Bases macho, Bases macho pasamuros con o sin cuello de salida de cables y Prolongadores macho.

The main characteristic of these connectors, is the concept of glass filled fibre Thermoplastic material, of the shells.

These connectors conform to the International Electrician Commission (CEI) specification, under category 665. The colour is black.

They are completely intermatable with the metallic size 20 series connectors, male receptacle, and female plug, using the same insulators (page 17 & 18).

This series comprises, female straight plugs, male receptacles, male bulkhead receptacles with or without back shells and cable clamps, and male cable connecting plugs.

La caractéristique principale de ces connecteurs est sa réalisation en polyamide renforcé (DURETHAN BKV) avec charge de fibre de verre. Ces connecteurs ont une excellente résistance à la corrosion.

Ils sont conformes aux spécifications de la Commission Electrotechnique Internationale (CEI) de la catégorie 665.

La couleur est noire, ils sont totalement compatibles et interconnectables avec les connecteurs métalliques de la taille 20 dans la version fiche femelle, embase mâle et prolongateur mâle, utilisant les memes isolants (page 17 et 18).

Cette série de connecteurs se compose donc de la fiche femelle droite, de l'embase mâle, de l'embase mâle pour traversée de cloison avec ou sans corps de prolongateur mâle de sortie de câble.

Nous pouvons de plus adapter tous les presse-étoupes de la taille 20 sur demande (Ref. 098).



**9201** ■■■■■ ■ P ■ P098



**9206** ■■■■■ ■ S ■ P



**92P2** ■■■■■ ■ P ■ P

Temperatura de utilización Operating temperature range Gamme de température	-25°C + 80°C
Resistencia al impacto (Izod) Impact resistance (Izod) Résistance au choc (Izod)	8 kg. cm/cm en entalla 8 kg cm/cm in notch 8 kg cm/cm en entaille
Alargamiento a la rotura Break down elongation Elongation maximum	3,59%
Resistencia a los ambientes ácidos, básicos o salinos Resistance to acid, alkaline and saline environments. Résiste à une ambiance acide, basique ou saline	Consultar fábrica Contact factory Consulter l'usine

FICHA HEMBRA

FEMALE STRAIGHT PLUG

FICHE FEMELLE DROITE

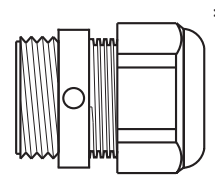
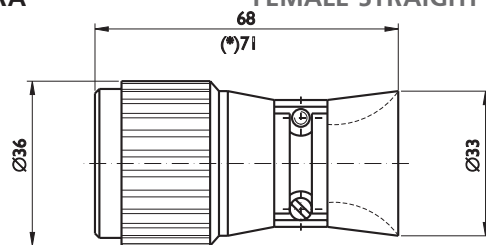

PROLONGADOR MACHO

MALE EXTENDER

PROLONGATEUR MÂLE

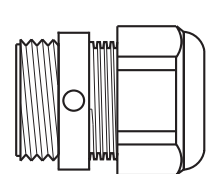
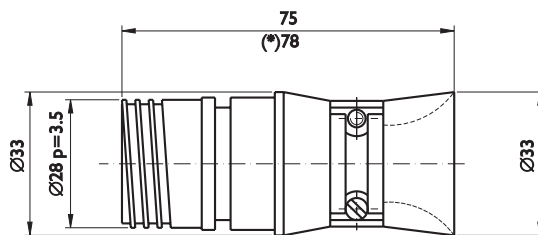

BASE MACHO

MALE RECEPTACLE

EMBASE MÂLE

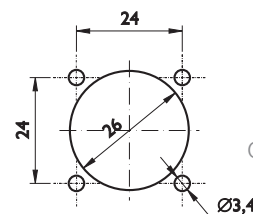
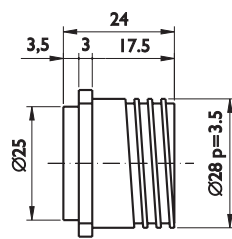
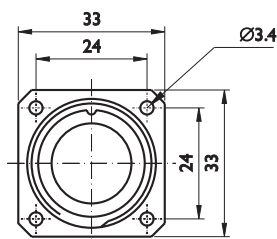

BASE MACHO PASAMUROS

WALL MOUNTING MALE RECEPTACLE

EMBASE MÂLE TRAVERSÉE DE CLOISON

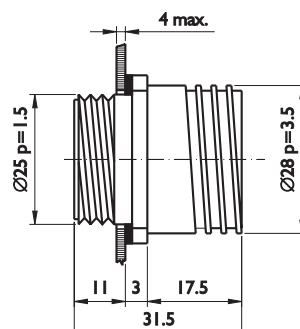



CONECTOR MACHO/HEMBRA MALE/FEMALE CONNECTOR CONNECTEUR MÂLE/FEMELLE



Un intercambiador macho/hembra

Male to female interconnector

Connecteur changeur de genre mâle/femelle.

ANTIVIBRATORIO

ANTIVIBRATION

ANTIVIBRATOIRE



Gracias a un sistema consistente en un fleje y un racord dentado, se evita el desenroscamiento de los conectores en ambientes expuestos a vibraciones.

Thanks to a simple but effective anti-vibration mechanism, consisting of a coupling ring with teeth and a flexible steel tongue riveted to the receptacle, the mated connectors withstand severe vibrations.

Les connecteurs peuvent être équipés d'un système ingénieux réalisé avec un ressort et un raccord denté, ils évitent que les connecteurs se désaccouplent dans les milieux exposés aux vibrations.

ZAMAK

ZAMAK

ZAMAK



Conectores con bajo porcentaje de aluminio utilizados en equipos aprobados EX.

Connectors manufactured in a special alloy with a low percentage of aluminium used in mining applications and on EX approved equipment.

Ces connecteurs avec un pourcentage réduit d'aluminium peuvent être utilisés dans des équipements approuvés pour ambiance EX.

**MARINA**

**MARINE**

**MARINE**



Una muestra de nuestros conectores "manfibio" usados en medios marinos, expuestos a fuertes vientos y violentas sacudidas.

A sample of our "manfibio" connector used in marine environments. Designed to withstand strong winds and heavy vibrations.

Voici un exemple de notre connecteur "manfibio" utilisé en ambiance marine, pour résister aux fortes secousses, aux vents violents et aux embruns.

**CIRCUITOS IMPRESOS**

**PCB BOARDS**

**CIRCUITS IMPRIMÉS**



Bases para circuito impreso, con diferentes longitudes de contactos.

Receptacles for PCB mounting, with different pin lengths.

Embases pour circuit imprimé, avec différentes longueurs de contact.

**ALTAS TEMPERATURAS**

**HIGH TEMPERATURES**

**HAUTES TEMPERATURES**

La serie circular puede ser adaptada para trabajar en ambientes con altas temperaturas.

The circular series can be modified to work in areas with high temperatures.

La série circulaire peut être modifiée pour travailler dans des environnements à haute température.

Para nuevas realizaciones especiales, consultar fábrica.

For customised design, contact factory.

Pour des réalisations spéciales, consulter l'usine.



Dentro de nuestra serie circular, el mayor conector y más versátil es el de tamaño 70.

Las características son descritas en cuadro inferior. Nos permite usar contactos a soldar hasta 125A y contactos a crimpar hasta 25A. Estos conectores también son antivibratorios e IP65

The size 70 is the largest and most versatile among our circular connectors. Solder contacts are available up to 125 amps and crimp contacts up to 25 amps. Secure locking system to withstand severe vibrations. Sealed when mated, to an IP65 rating.

Parmi tous le connecteurs cylindriques, il existe un connecteur de taille 70, qui est le plus grand et le plus complet.

Les caractéristiques sont décrites dans le tableau suivant. Nous pouvons monter des contacts à souder de 125 A et des contacts à sertir de 25A. Ils sont antivibratoire et IP65.



DIMENSIONES CON CONECTORES ENSAMBLADOS

DIMENSIONS WITH MATED CONNECTORS

DIMENSIONS AVEC LES CONNECTEURS ACCOUPlés

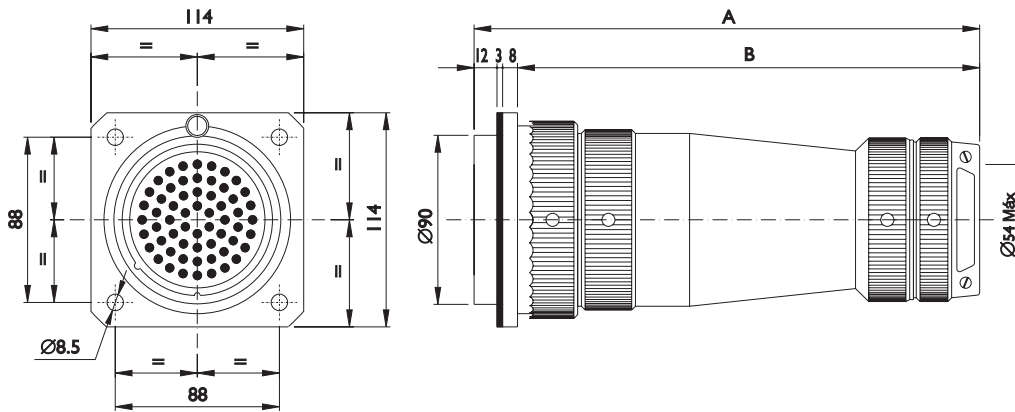

	Cuello corto Short backshell Corps court	Cuello largo Long backshell Corps long
	Hembra Female Femelle	Hembra Female Femelle
<b>A</b>	<b>240</b>	<b>300</b>
<b>B</b>	<b>202</b>	<b>289</b>

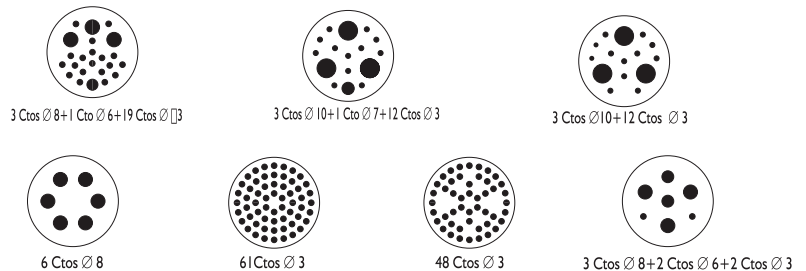

**CARACTERISTICAS MATERIALES****MATERIAL DATA****CARACTERISTIQUES DES MATERIAUX**

Cuerpo Shell Corps	Aleación de Aluminio Aluminium Alloy Alliage Aluminium
Acabado Finish Finition	2 y 6 2 and 6 2 et 6
Aislante Insulator Isolant	PETP
Contactos Contacts Contacts	Aleación de cobre Cooper alloy Alliage cuivreux
Protección Contactos Contact Plating Traitement de surface	Oro sobre níquel Gold on nickel Dorure sur sous-couche nickel
Juntas Seals Joints	EPDM
Enclave Racord Coupling Nut Bille de Sécurité	Acero inoxidable AISI-304 Stainless steel AISI-304 Acier inoxydable AISI-304

**CARACTERISTICAS TECNICAS****TECHNICAL DATA****CARACTERISTIQUES TECHNIQUES**

Resistencia Aislamiento Insulation Resistance Résistance d'isolement	20 °C	$5 \cdot 10^{12} \Omega/\text{cm}$
Aislamiento conduct. termica Termic conductivity Isolation Isolant conductivité Thermique		0,29 w/m
Tensión ensayo (nivel mar) Test voltage (sea level) Tension d'essai (niveau de la mer)		según modelo plan-form dependant selon modèle
Tensión servicio a nivel del mar Working voltage at sea level Tension de service au niveau de la mer		según modelo plan-form dependant selon modèle
Temperatura de utilización Working temperature Température d'utilisation		-30°C a +160 °C
Rigidez dieléctrica Dielectric strength Rigidité diélectrique		> 15 kV/mm
Grado de protección Protection level Indice de protection		IP65 (IEC 529)

**CONTACTOS****CONTACTS****CONTACTS**

CALIBRE CALIBRE CALIBRE	SOLDAR SOLDER A SOUDER				CRIMPAR CRIMP A SERTIR
	6	7	8	10	3
INTENSIDAD NOMINAL (A) WORKING CURRENT (A) INTENSITÉ NOMINALE (A)	50	64	80	125	25
Ø MAXIMO DE CABLE (mm) MAX WIRE Ø (mm) Ø MAX DU FIL (mm)	5,5	6,5	8	10	3
SECCIÓN DEL CABLE (mm <sup>2</sup> ) WIRE SECTION (mm <sup>2</sup> ) SECTION DU FIL (mm <sup>2</sup> )	10	16	25	35	*

**CONTACTOS Y ÚTILES DE ENGASTADO****CRIMP CONTACTS AND TOOLS****CONTACTS ET OUTILS A SERTIR**

Sección del cable Wire section Section du câble			Referencia de contacto Contact part number Référence du contact		Útiles de Engastado Crimp Tools Outils à Sertir			
mm <sup>2</sup>	AWG	Max (mm)	Macho Male Mâle	Hembra Female Femelle	Tenaza regulable Adjustable Tool Pince Réglable	Torreta Positioner Positionneur	Insertor Insertion Insertion	Extractor Extraction Extracteur
4	8-10	3,2	PCX140	SXC139	H0M309	H0SH480	—	92UE125
2,5	12	2,5	PXC82	SXC81	H0M309	H0SH480	—	92UE125
1,5	16	1,7	PXC86	SXC85	H0M309	H0SH480	—	92UE125



**INDICE****LIST OF CONTENTS****LEGENDE**

Caraterísticas técnicas	Technical data	Caractéristiques Techniques	4
Dimensiones	Dimensions	Dimensions	
– Bases	– Receptacles	– Embase	5
– Prolongador hembra	– Female extender	– Prolongateur femelle	6
– Prolongador macho	– Male extender	– Prolongateur mâle	7
– Ficha hembra	– Straight female plug	– Fiche femelle	8
– Ficha macho	– Straight male plug	– Fiche mâle	9
– Ficha codo	– Angled plug	– Fiche coudée	10
– Base racord	– Receptacle with coupling nut	– Embase à ecrou	11
– Conectores ensamblados	– Mated connectors	– Connecteurs accouplés	12
Salida de cable	Cable clamp	Sortie de câble	13
Descripción comercial	Reference	Description commerciale	14
Cuerpos macho	Male bodies	Corps mâle	15
Cuerpos hembra	Female bodies	Corps femelle	16
Contactos a soldar	Solder contacts	Contacts à souder	17
Contactos a engastar	Crimp contacts	Contacts à sertir	18
Tapones metálicos	Metal caps	Bouchons métalliques	19
Accesorios	Accessories	Accessoires	20
Iluminación y sonido	Light and sound	Son et lumière	21
Conector a bayoneta	Bayonet connector	Connecteur à baïonnette	22
Manfibio	Manfibio	Manfibio	22
Serie 90	Series 90	Série 90	23
Serie alta tensión (AT)	High voltage series (AT)	Série haute tension (AT)	23
Conector de plástico	Plastic connector	Connecteur en plastique	24
– Características	– Characteristics	– Caractéristiques	25
Realizaciones especiales	Customised designs	Réalisations spéciales	26
Realizaciones especiales	Customised designs	Réalisations spéciales	27
Tamaño 70	Size 70	Taille 70	28
– Características	– Characteristics	– Caractéristiques	29

Nuestra sociedad se reserva el derecho de modificar parcial o totalmente las características de estos conectores sin previo aviso.  
Our company reserves the right to make partial or total modifications of the characteristics of these connectors without previous notice.  
Notre société se réserve le droit de modifier partiellement ou totalement les caractéristiques sans pré-avis.

